

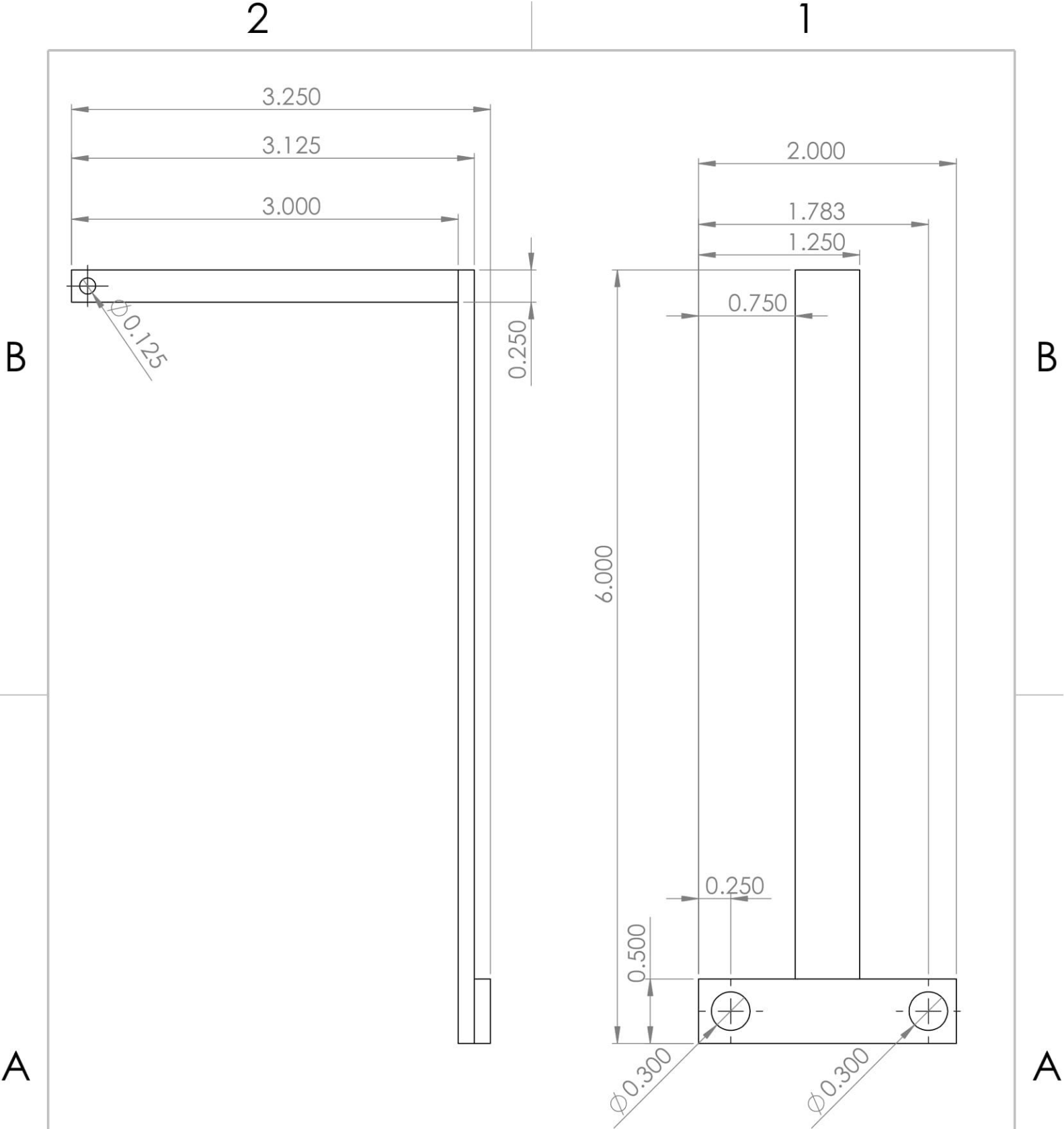

2nd Cad Drawing
1/24/2022

Andrew Harper-Smith	70%
Parmvir Singh	20%
Amanda Harkleroad	10%



PROPRIETARY AND CONFIDENTIAL
 THE INFORMATION CONTAINED IN THIS DRAWING IS THE SOLE PROPERTY OF AAAMP. ANY REPRODUCTION IN PART OR AS A WHOLE WITHOUT THE WRITTEN PERMISSION OF AAAMP IS PROHIBITED.

DIMENSIONS ARE IN INCHES	
MATERIAL	Steel
FINISH	N/A
APPLICATION	DO NOT SCALE DRAWING

NAME	DATE
DRAWN AH-S	1/24/2022
CHECKED PS	1/30/2022
ENG APPR.	
MFG APPR.	
Q.A.	
COMMENTS:	

<h1>Pivot Arm</h1>		
SIZE A	DWG. NO. 02	REV.
SCALE: 1:2	WEIGHT:	SHEET 1 OF 1

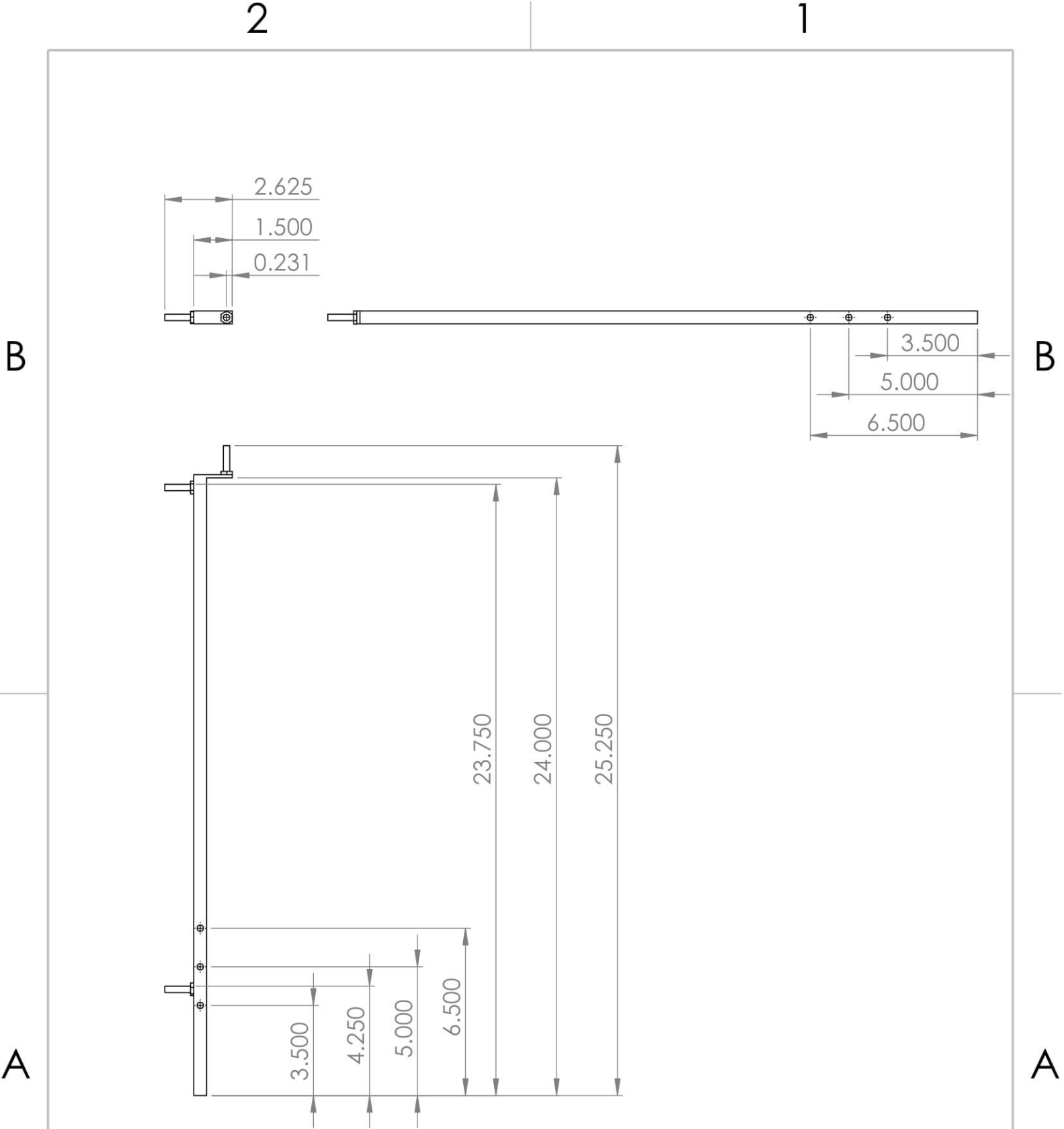

<p>PROPRIETARY AND CONFIDENTIAL</p> <p>THE INFORMATION CONTAINED IN THIS DRAWING IS THE SOLE PROPERTY OF AAAMP. ANY REPRODUCTION IN PART OR AS A WHOLE WITHOUT THE WRITTEN PERMISSION OF AAAMP IS PROHIBITED.</p>		<p>DIMENSIONS ARE IN INCHES</p> <p>All Holes are 0.25" in diameter</p>		NAME	DATE	<p>Left Front Solar Mount</p>
		DRAWN	AH-S	1/30/2022		
CHECKED	PS	1/30/2022				
ENG APPR.						
MATERIAL		Steel		MFG APPR.		<p>Q.A.</p> <p>COMMENTS:</p> <p>Uses 1"x1/4" bolts welded on</p>
NEXT ASSY	USED ON	FINISH		N/A		
APPLICATION		DO NOT SCALE DRAWING		SIZE	DWG. NO.	REV.
				A	05	
				SCALE:1:10	WEIGHT:	SHEET 1 OF 1

2

1

B

B

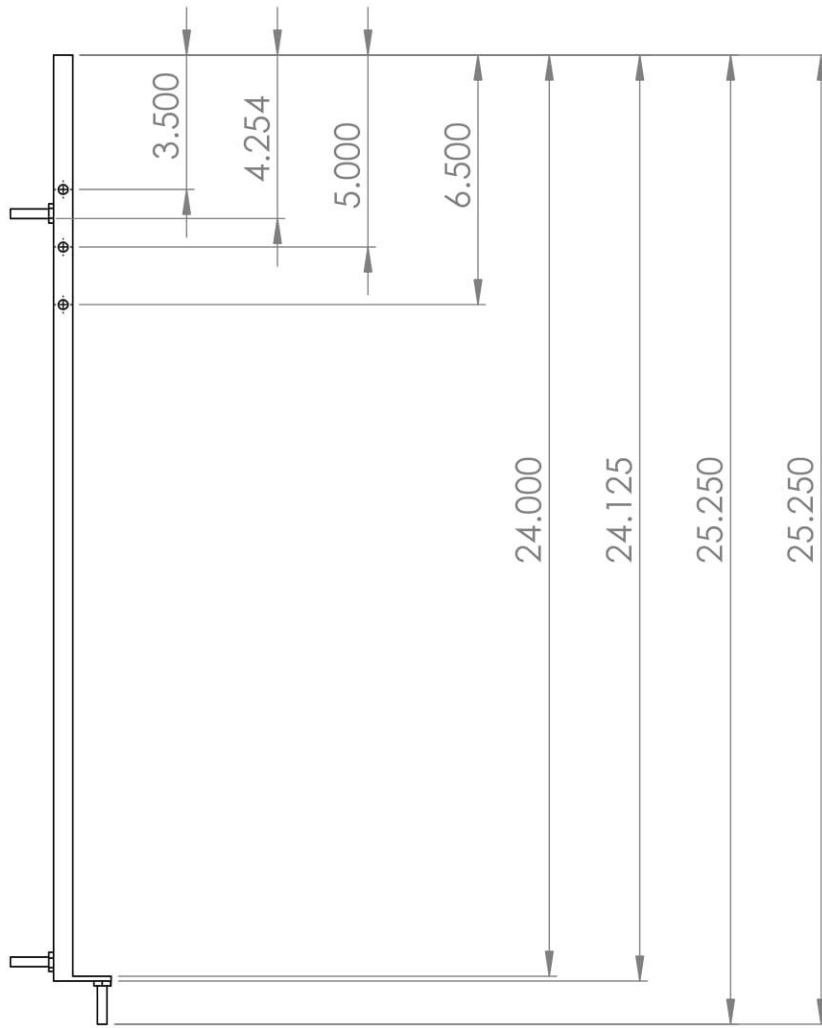

A

A



PROPRIETARY AND CONFIDENTIAL
 THE INFORMATION CONTAINED IN THIS DRAWING IS THE SOLE PROPERTY OF AAAMP. ANY REPRODUCTION IN PART OR AS A WHOLE WITHOUT THE WRITTEN PERMISSION OF AAAMP IS PROHIBITED.

		DIMENSIONS ARE IN INCHES All holes have a 0.25" diameter		NAME	DATE
				DRAWN	AH-S 1/30/2022
				CHECKED	PS 1/30/2022
				ENG APPR.	
				MFG APPR.	
				Q.A.	
				COMMENTS: Uses 1"x1/4" bolts welded on	
NEXT ASSY	USED ON	MATERIAL	Steel		
		FINISH	N/A		
APPLICATION		DO NOT SCALE DRAWING			

Left Rear Solar Mount

SIZE	DWG. NO.	REV.
A	06	
SCALE:1:10	WEIGHT:	SHEET 1 OF 1

1

2

1

B

B

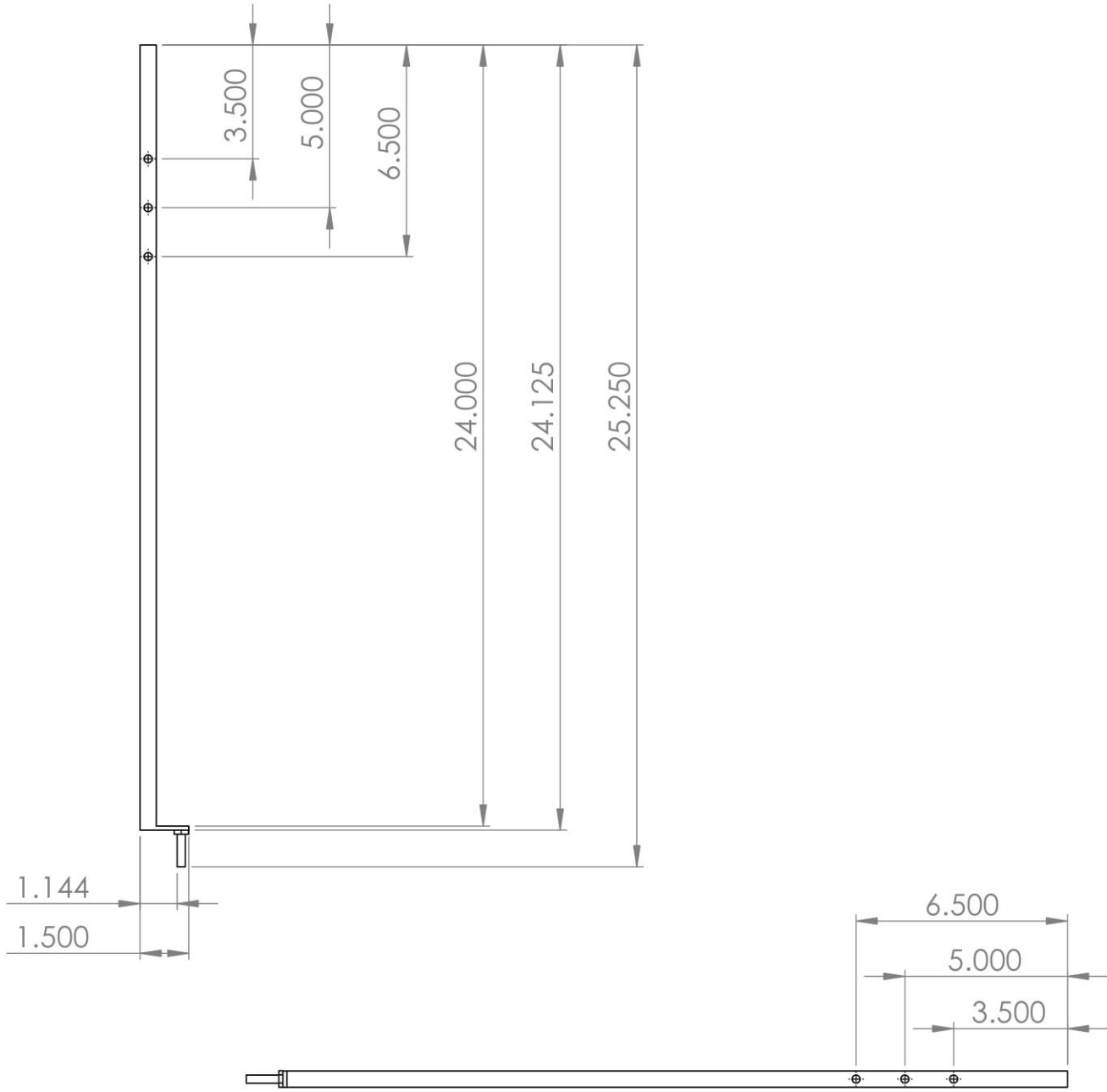

A

A

PROPRIETARY AND CONFIDENTIAL
 THE INFORMATION CONTAINED IN THIS DRAWING IS THE SOLE PROPERTY OF AAAMP. ANY REPRODUCTION IN PART OR AS A WHOLE WITHOUT THE WRITTEN PERMISSION OF AAAMP IS PROHIBITED.

		DIMENSIONS ARE IN INCHES All holes are 0.25" in diameter		NAME	DATE
				DRAWN	AH-S 1/30/2022
				CHECKED	PS 1/30/2022
				ENG APPR.	
				MFG APPR.	
				Q.A.	
				COMMENTS: Uses a 1"x1/4" bolt welded on	
NEXT ASSY	USED ON	MATERIAL	Steel		
		FINISH	N/A		
APPLICATION		DO NOT SCALE DRAWING			

Right Front Solar Mount			SIZE	DWG. NO.	REV.
			A	07	
SCALE:1:10		WEIGHT:		SHEET 1 OF 1	

1

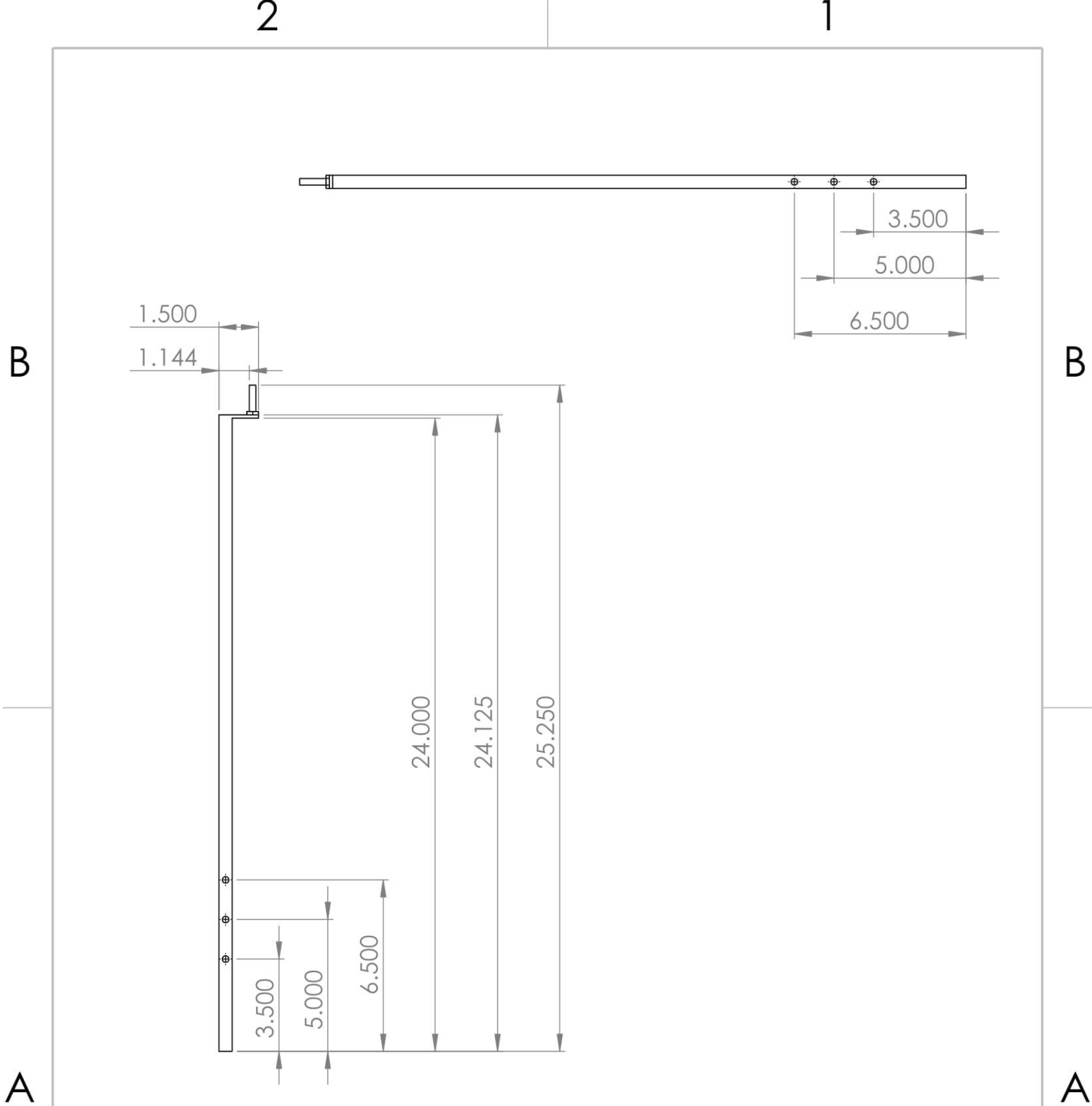

		DIMENSIONS ARE IN INCHES Hole dia. .25 unless otherwise noted		NAME	DATE
		MATERIAL Steel		DRAWN	AH-S 1/30/2022
		FINISH N/A		CHECKED	PS 1/30/2022
NEXT ASSY	USED ON			ENG APPR.	
APPLICATION		DO NOT SCALE DRAWING		MFG APPR.	
				Q.A.	
				COMMENTS:	
				Uses a 1"x1/4" bolts welded on	

Right Rear Solar Mount			REV.
SIZE	DWG. NO.	REV.	
A	08		
SCALE: 1:10	WEIGHT:	SHEET 1 OF 1	

PROPRIETARY AND CONFIDENTIAL
THE INFORMATION CONTAINED IN THIS DRAWING IS THE SOLE PROPERTY OF AAAMP. ANY REPRODUCTION IN PART OR AS A WHOLE WITHOUT THE WRITTEN PERMISSION OF AAAMP IS PROHIBITED.

2

1

B

B

A

A

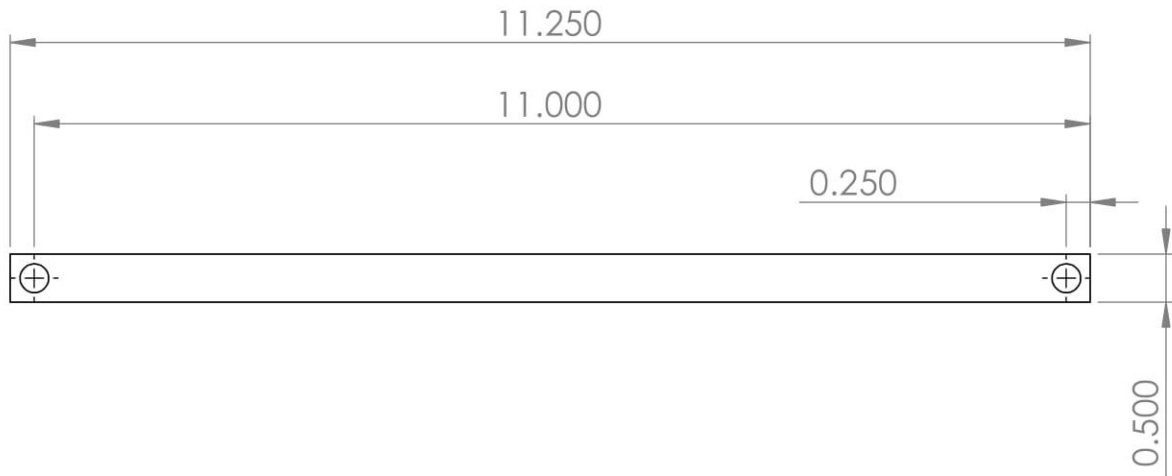

PROPRIETARY AND CONFIDENTIAL
 THE INFORMATION CONTAINED IN THIS DRAWING IS THE SOLE PROPERTY OF AAAMP. ANY REPRODUCTION IN PART OR AS A WHOLE WITHOUT THE WRITTEN PERMISSION OF AAAMP IS PROHIBITED.

		DIMENSIONS ARE IN INCHES Hole dia .3 unless otherwise noted 1/2" by 1/2" square tubing	NAME	DATE	<h1>A-Arm</h1>	
			DRAWN	AH-S 1/30/2022		
			CHECKED	PS 1/30/2022		
			ENG APPR.			
		MATERIAL	MFG APPR.		SIZE A DWG. NO. 09 REV. SCALE:1:5 WEIGHT: SHEET 1 OF 1	
		Steel	Q.A.			
		FINISH	COMMENTS:			
Quantity	4	N/A				
APPLICATION		DO NOT SCALE DRAWING				

2

1

2

1

B

B

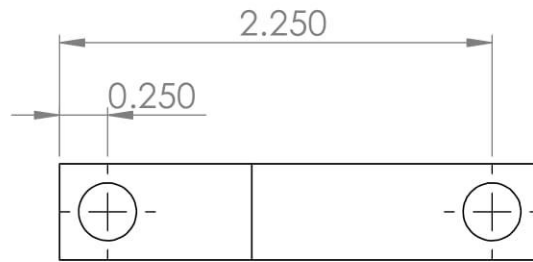
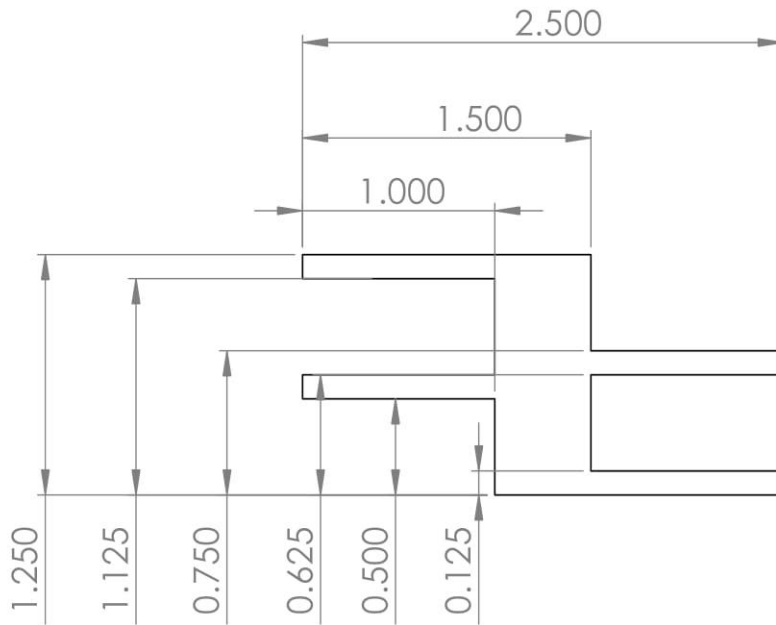

A

A

PROPRIETARY AND CONFIDENTIAL
 THE INFORMATION CONTAINED IN THIS DRAWING IS THE SOLE PROPERTY OF AAAMP. ANY REPRODUCTION IN PART OR AS A WHOLE WITHOUT THE WRITTEN PERMISSION OF AAAMP IS PROHIBITED.

		DIMENSIONS ARE IN INCHES Hole dia .3 unless otherwise noted Holes are through all	NAME	DATE
			DRAWN	AH-S 1/30/2022
			CHECKED	PS 1/30/2022
			ENG APPR.	
			MFG APPR.	
			Q.A.	
			COMMENTS:	
Quantity	4	MATERIAL Steel		
		FINISH N/A		
APPLICATION		DO NOT SCALE DRAWING		

A-Arm Mount

SIZE	DWG. NO.	REV.
A	10	
SCALE: 1:1	WEIGHT:	SHEET 1 OF 1

2

1

2

1

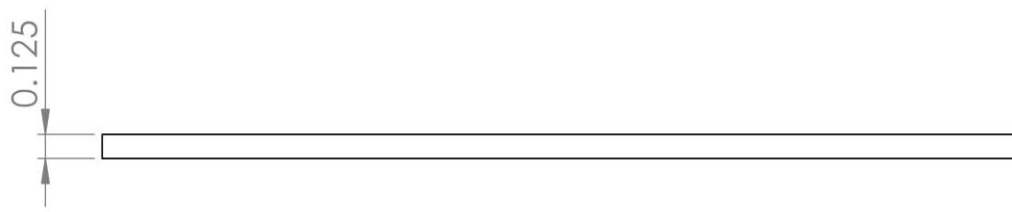
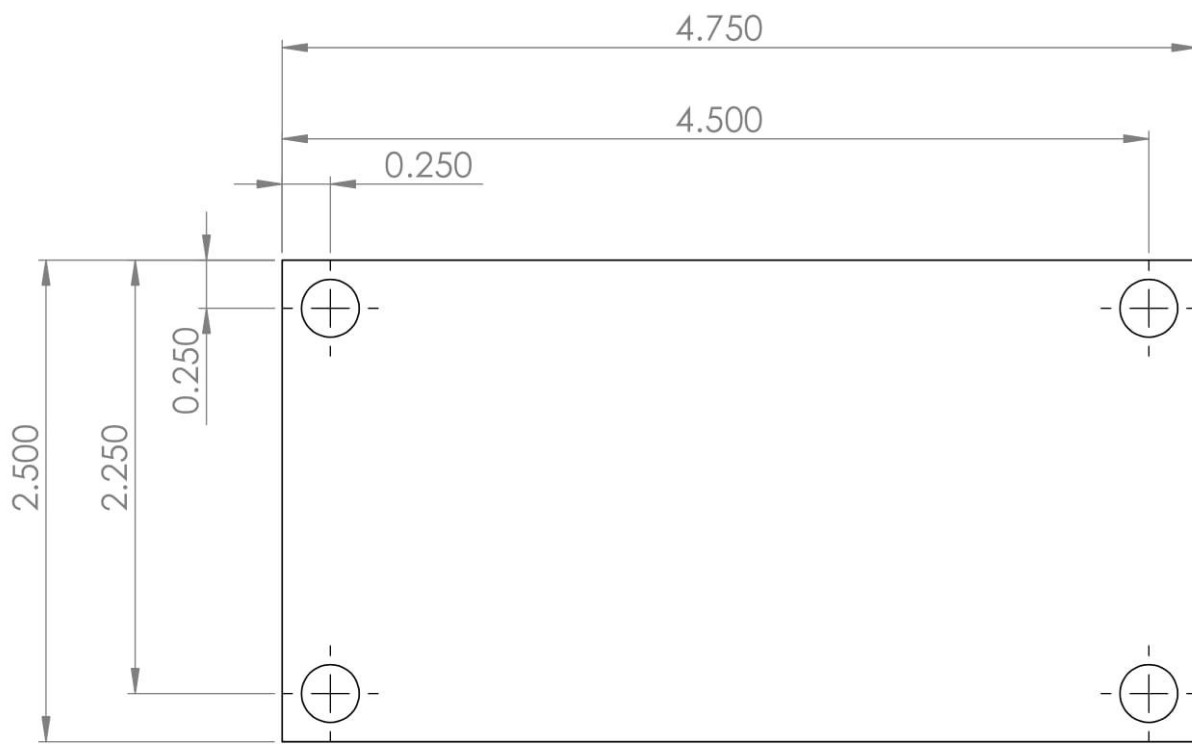

B

B

A

A

PROPRIETARY AND CONFIDENTIAL
 THE INFORMATION CONTAINED IN THIS DRAWING IS THE SOLE PROPERTY OF AAAMP. ANY REPRODUCTION IN PART OR AS A WHOLE WITHOUT THE WRITTEN PERMISSION OF AAAMP IS PROHIBITED.

		DIMENSIONS ARE IN INCHES Hole dia .3 unless otherwise noted		NAME	DATE
				DRAWN	AH-S 1/30/2022
				CHECKED	PS 1/20/2022
				ENG APPR.	
				MFG APPR.	
				Q.A.	
				COMMENTS:	
NEXT ASSY	USED ON	MATERIAL	Steel		
		FINISH	N/A		
APPLICATION		DO NOT SCALE DRAWING			

<h1>Motor Mount</h1>		
SIZE	DWG. NO.	REV.
A	11	
SCALE: 1:2	WEIGHT:	SHEET 1 OF 1

2

1